

NO.	PART NUMBER	DESCRIPTION	Default/QTY.	TH	W	L	Material	Volume inches^3
1	Part1	Bracket-a	1	3/4"	9"	10"	Pine	31.79
2	Part2	Bracket-b	1	3/4"	9"	10"	Pine	32.01
3	Part3	Cleat	2	3/4"	1 3/4"	9 1/2"	Pine	9.98
4	Part4	Slat	5	3/4"	1 3/4"	38"	Pine	47.80
5	Part5	Back	1	3/4"	4"	31 3/4"	Pine	92.31
6	Wood Shaker Peg 3-1-2-Inch 1-2 Tenon		7				Maple	0.99
7	Keyhole Hanger Plate 1-3-4-Inch		2				Steel	0.08
8	screw M3.5 x 25 (#6 x 1in. Flat Head)	Wood Screw Phillips Flat Head #6 x 1"	4				Steel	
9	screw M4 x 40 (#8 x 1-1,2in. Flat Head)	Wood Screw Phillips Flat Head #8 x 1-1/2"	20				Steel	

Web Site: <a href="http://www.Eoutset.com">www.Eoutset.com</a>			TITLE: <b>Assembly Drawing</b>		
DRAWN	NAME: <b>Bright Bai</b>	DATE: <b>2016/2/25</b>	MATERIAL:		
Created Date: <b>2016/2/25 19:34:21</b>		FINISH:		DWG NO. <b>Versatile Shelf Plan</b>	
Last Save Date: <b>2016/2/25 19:57:55</b>		Volume: <b>422.66 inches^3</b>		A4	
Author Email: <b>brightbai@hotmail.com</b>		Weight: <b>5.28 pounds</b>		SCALE: 1:2	
			SHEET 1 OF 2		REVISION

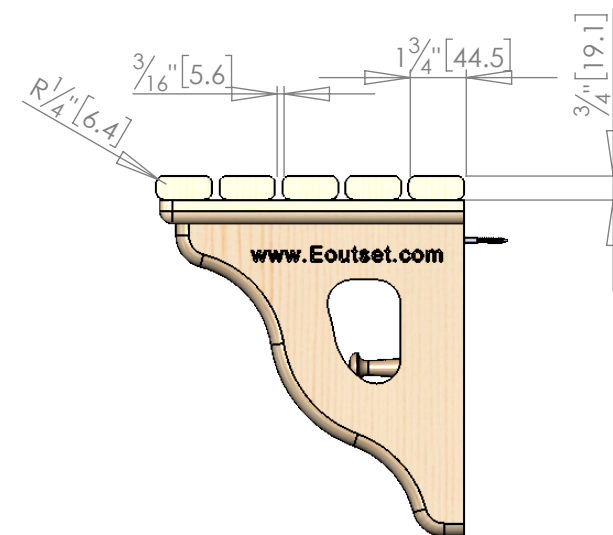

9 5/8" [244.5]

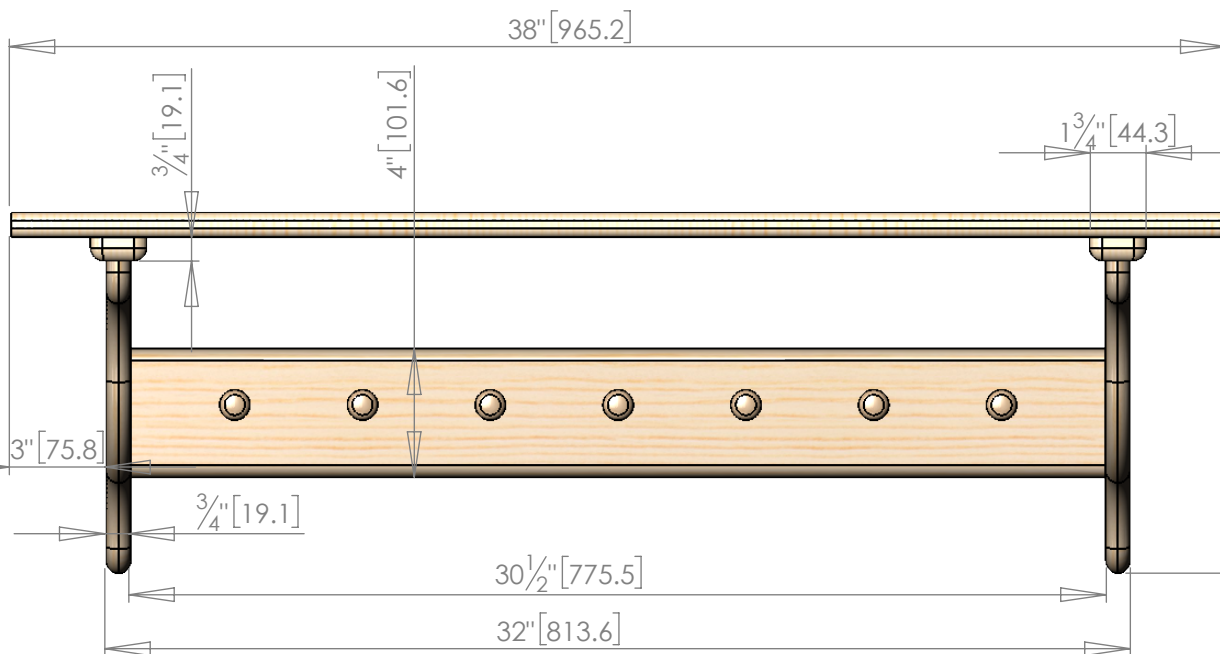
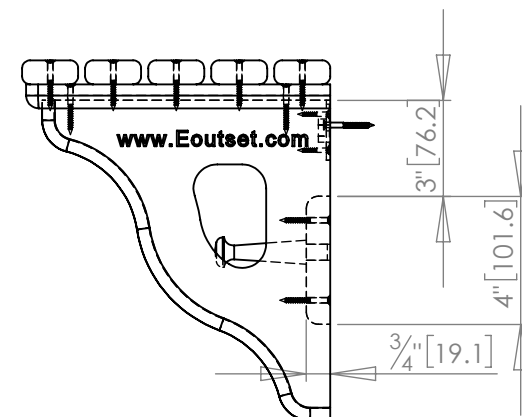

Web Site:		<a href="http://www.Eoutset.com">www.Eoutset.com</a>	
DRAWN	NAME	DATE	MATERIAL:
	Bright Bai	2016/2/25	
Created Date:		2016/2/25 19:34:21	
Last Save Date:		2016/2/25 19:57:55	
Author Email:		brightbai@hotmail.com	
FINISH:		Volume: 422.66 inches^3	
Weight:		5.28 pounds	

TITLE:		<b>Assembly Drawing</b>	
DWG NO.		Versatile Shelf Plan	
SCALE: 1:6		SHEET 2 OF 2	
REVISION		A4	

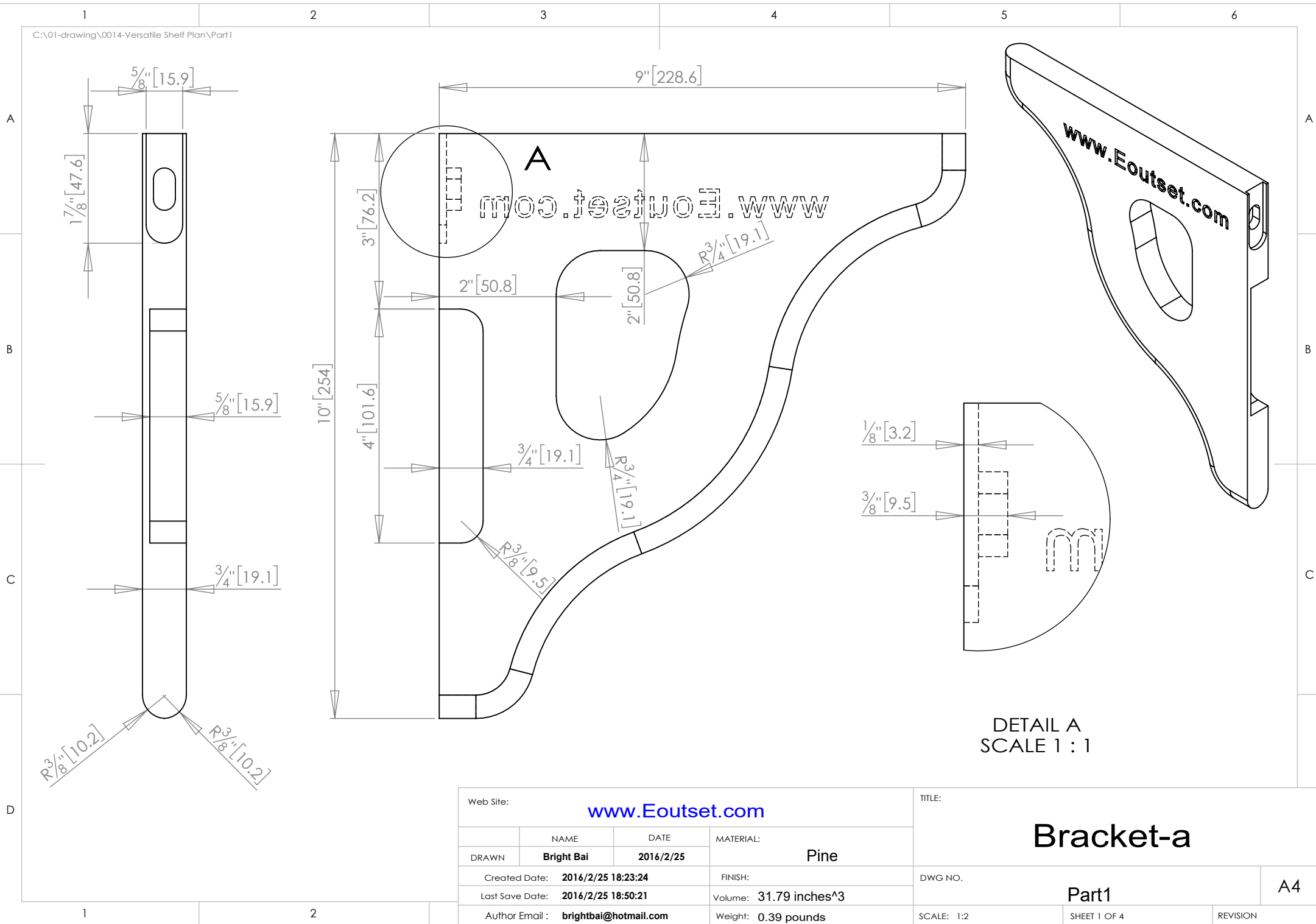

DETAIL A  
SCALE 1 : 1

Web Site: <a href="http://www.Eoutset.com">www.Eoutset.com</a>			TITLE: <b>Bracket-a</b>	
DRAWN	NAME	DATE	MATERIAL: <b>Pine</b>	
	<b>Bright Bai</b>	<b>2016/2/25</b>		
Created Date: <b>2016/2/25 18:23:24</b>			FINISH:	DWG NO.
Last Save Date: <b>2016/2/25 18:50:21</b>			Volume: <b>31.79 inches^3</b>	<b>Part1</b>
Author Email: <b>brightbai@hotmail.com</b>			Weight: <b>0.39 pounds</b>	<b>A4</b>
			SCALE: 1:2	SHEET 1 OF 4
			REVISION	

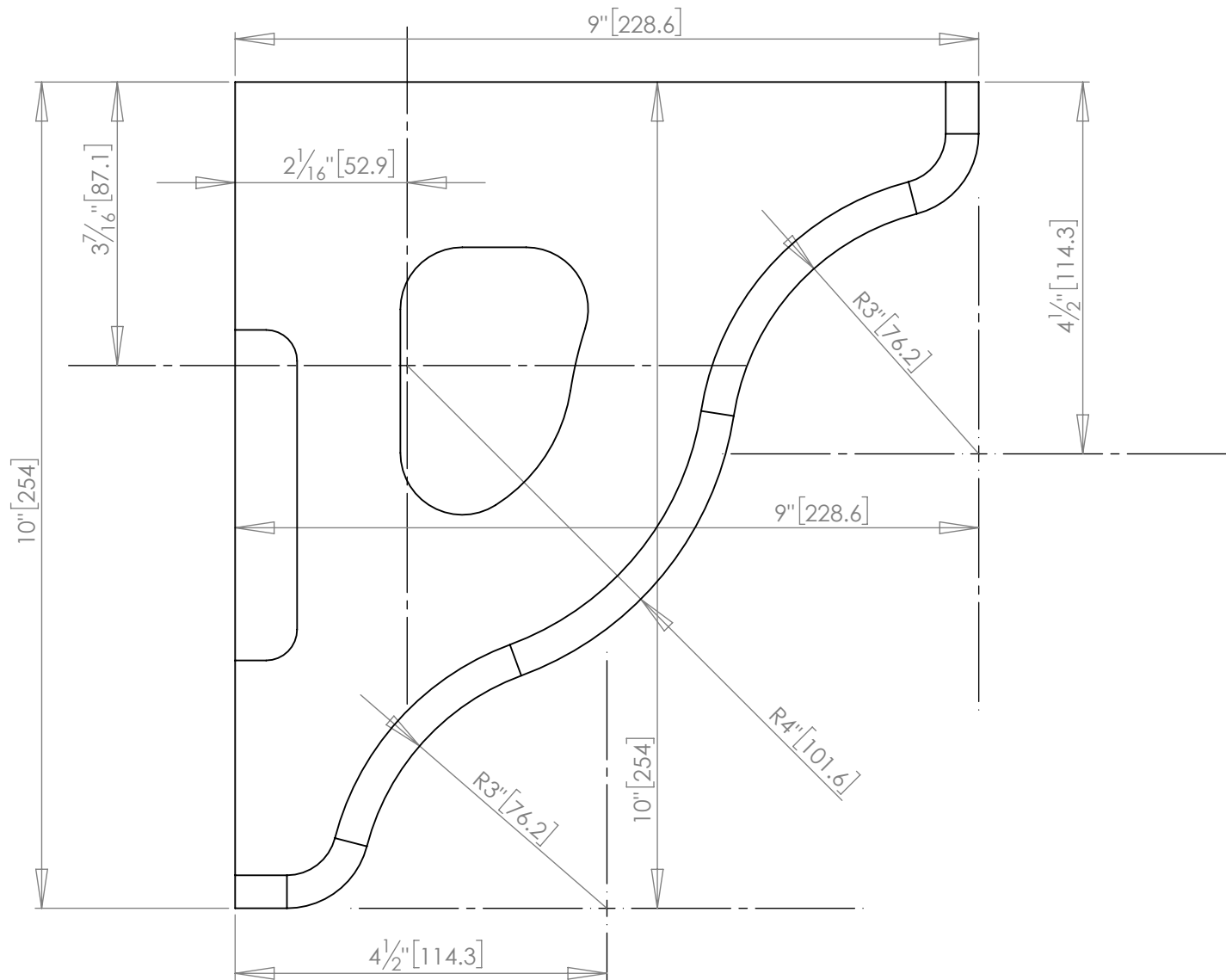

Web Site: <a href="http://www.Eoutset.com">www.Eoutset.com</a>			TITLE: <b>Bracket-a</b>	
DRAWN	NAME <b>Bright Bai</b>	DATE <b>2016/2/25</b>	MATERIAL: <b>Pine</b>	
Created Date: <b>2016/2/25 18:23:24</b>		FINISH:		DWG NO.
Last Save Date: <b>2016/2/25 18:50:21</b>		Volume: <b>31.79 inches^3</b>		<b>Part1</b>
Author Email: <b>brightbai@hotmail.com</b>		Weight: <b>0.39 pounds</b>		<b>A4</b>
SCALE: 1:2			SHEET 2 OF 4	
			REVISION	

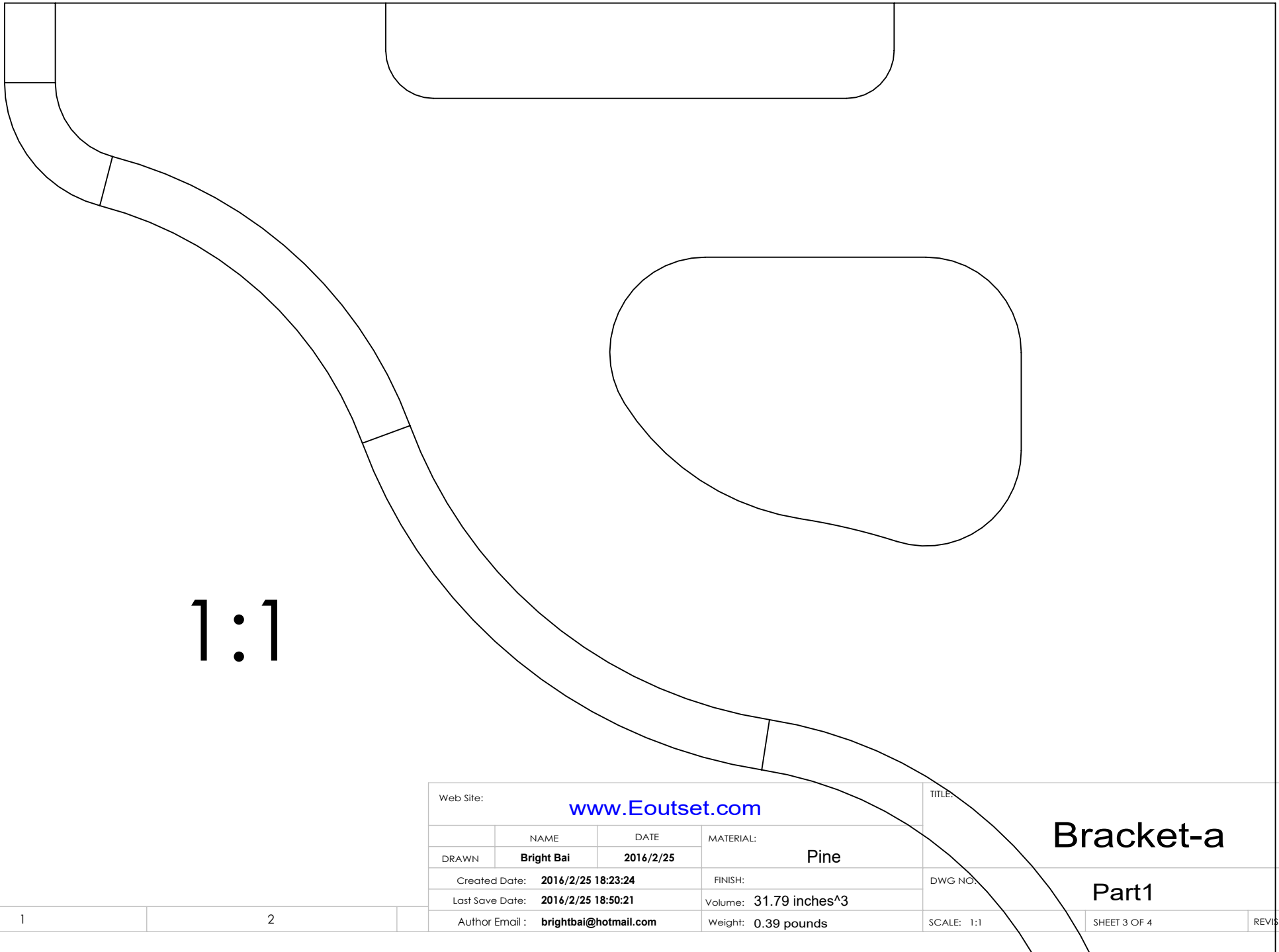

Web Site: <a href="http://www.Eoutset.com">www.Eoutset.com</a>			TITLE: <b>Bracket-a</b>	
	NAME	DATE	MATERIAL:	
DRAWN	<b>Bright Bai</b>	<b>2016/2/25</b>	<b>Pine</b>	
Created Date: <b>2016/2/25 18:23:24</b>			FINISH:	DWG NO:
Last Save Date: <b>2016/2/25 18:50:21</b>			Volume: <b>31.79 inches^3</b>	<b>Part1</b>
Author Email: <b>brightbai@hotmail.com</b>			Weight: <b>0.39 pounds</b>	<b>A4</b>
			SCALE: 1:1	SHEET 3 OF 4
			REVISION	

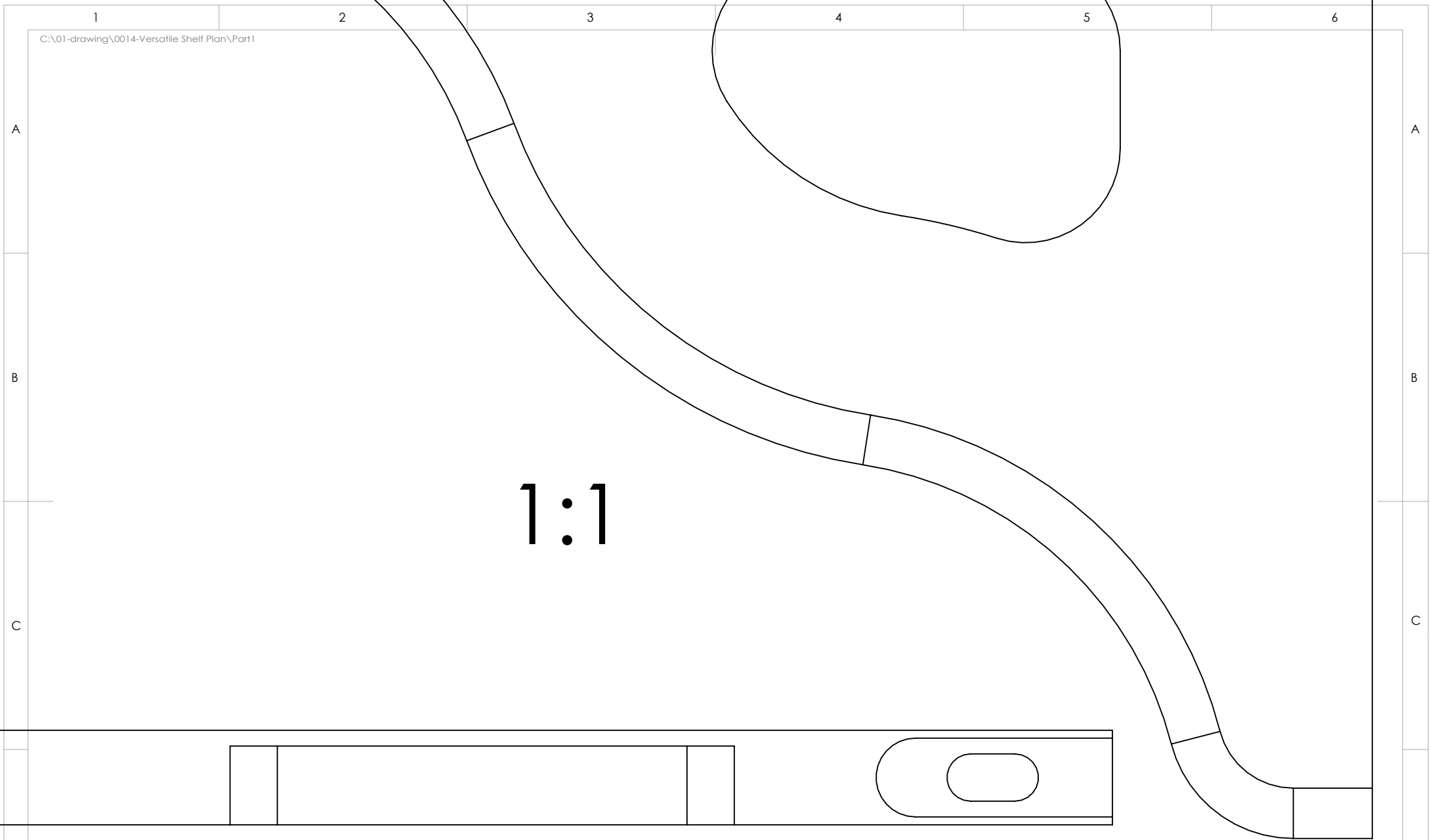

1:1

Web Site: <a href="http://www.Eoutset.com">www.Eoutset.com</a>			TITLE: <b>Bracket-a</b>	
DRAWN	NAME <b>Bright Bai</b>	DATE <b>2016/2/25</b>	MATERIAL: <b>Pine</b>	
Created Date: <b>2016/2/25 18:23:24</b>			FINISH:	DWG NO. <b>Part1</b>
Last Save Date: <b>2016/2/25 18:50:21</b>			Volume: <b>31.79 inches^3</b>	<b>A4</b>
Author Email: <b>brightbai@hotmail.com</b>			Weight: <b>0.39 pounds</b>	SCALE: 1:5
			SHEET 4 OF 4	REVISION

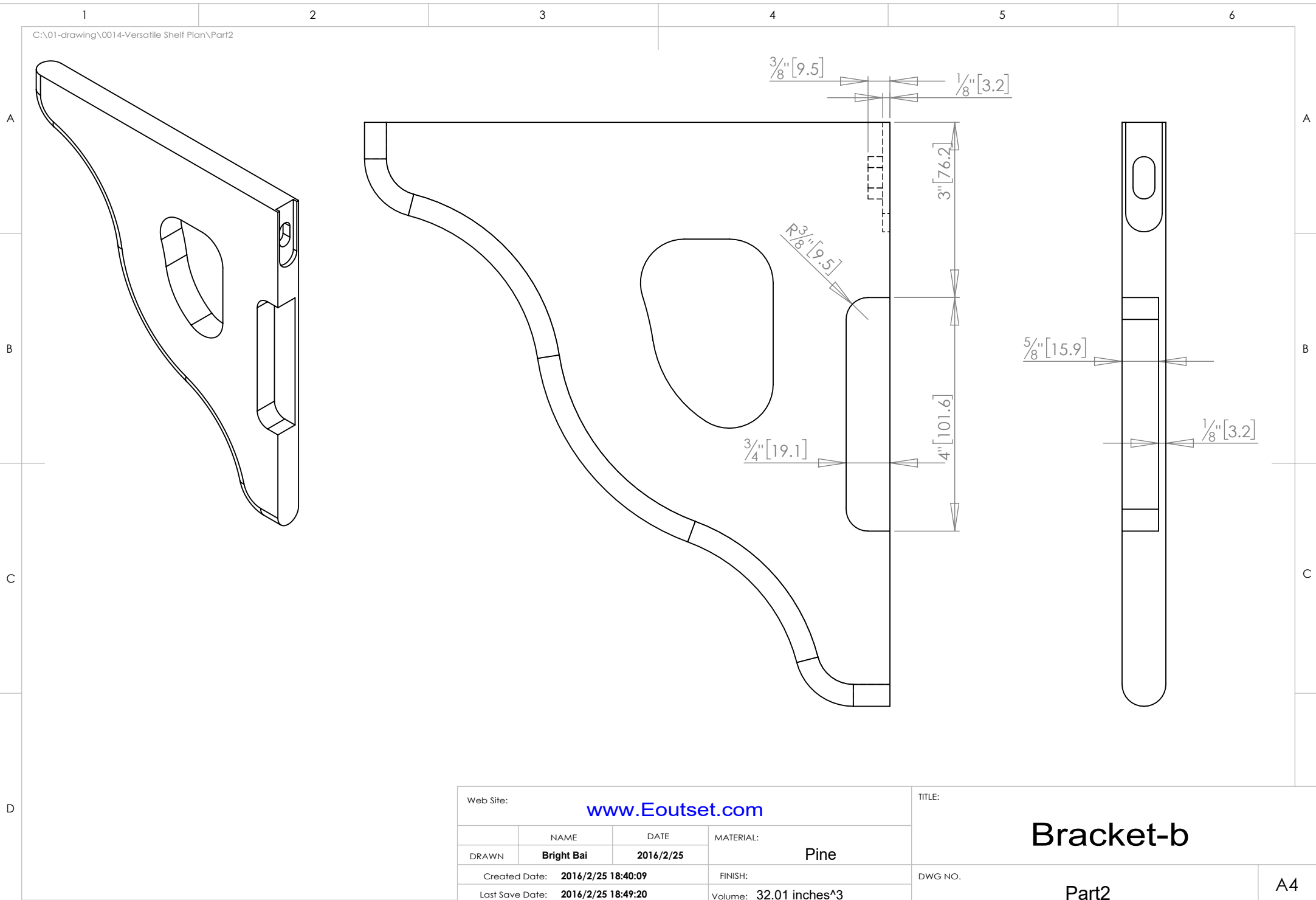

Web Site: <a href="http://www.Eoutset.com">www.Eoutset.com</a>			TITLE: <b>Bracket-b</b>		
DRAWN	NAME <b>Bright Bai</b>	DATE <b>2016/2/25</b>	MATERIAL: <b>Pine</b>		
Created Date: <b>2016/2/25 18:40:09</b>			DWG NO. <b>Part2</b>		
Last Save Date: <b>2016/2/25 18:49:20</b>			Volume: <b>32.01 inches^3</b>		
Author Email: <b>brightbai@hotmail.com</b>			Weight: <b>0.39 pounds</b>		SCALE: 1:2
			SHEET 1 OF 3		REVISION

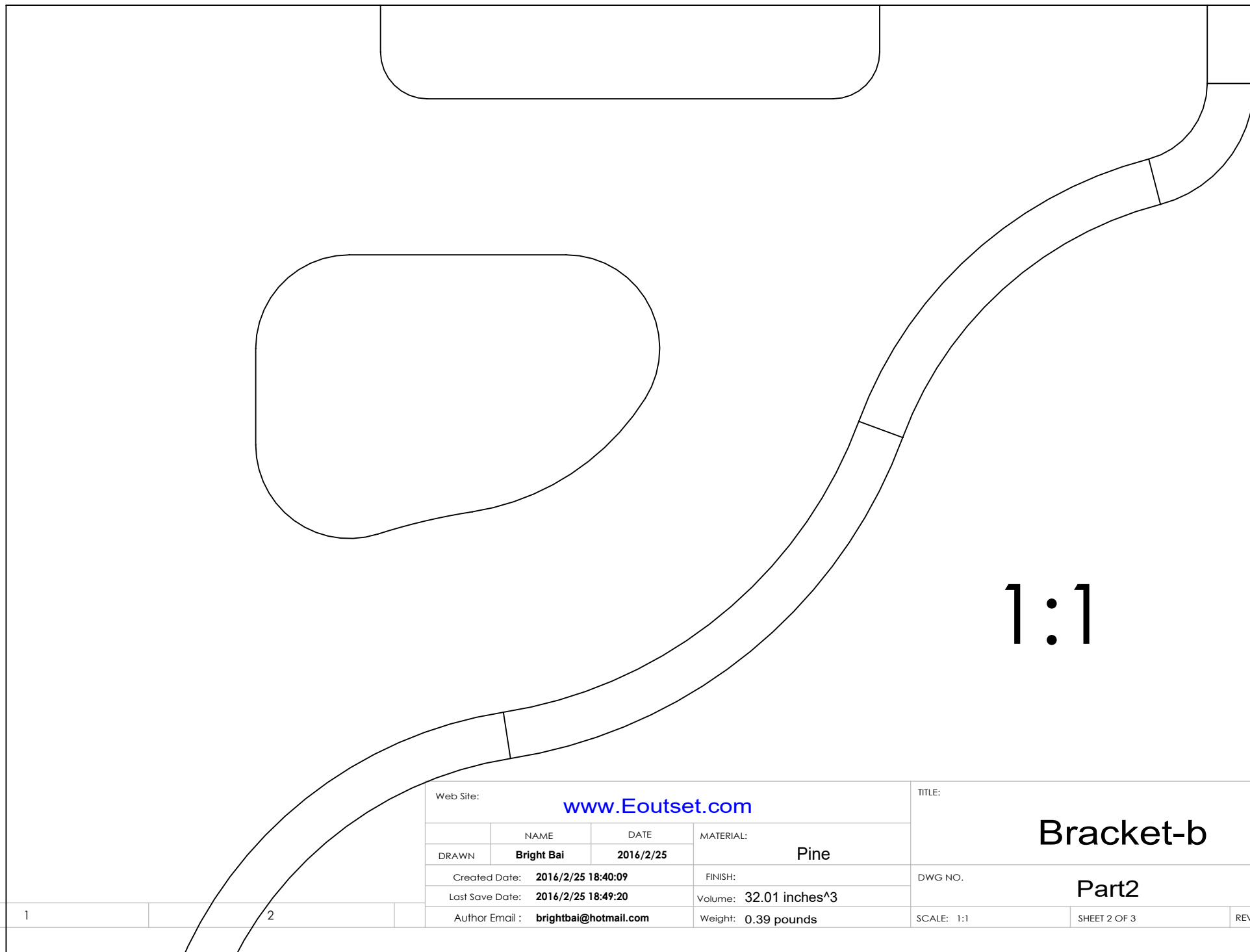

1:1

Web Site: <a href="http://www.Eoutset.com">www.Eoutset.com</a>			TITLE: <b>Bracket-b</b>		
DRAWN	NAME	DATE	MATERIAL: Pine		
	<b>Bright Bai</b>	<b>2016/2/25</b>			
Created Date: <b>2016/2/25 18:40:09</b>			FINISH:		DWG NO. <b>Part2</b>
Last Save Date: <b>2016/2/25 18:49:20</b>			Volume: <b>32.01 inches^3</b>		<b>A4</b>
Author Email: <b>brightbai@hotmail.com</b>			Weight: <b>0.39 pounds</b>		SCALE: 1:1
			SHEET 2 OF 3		REVISION



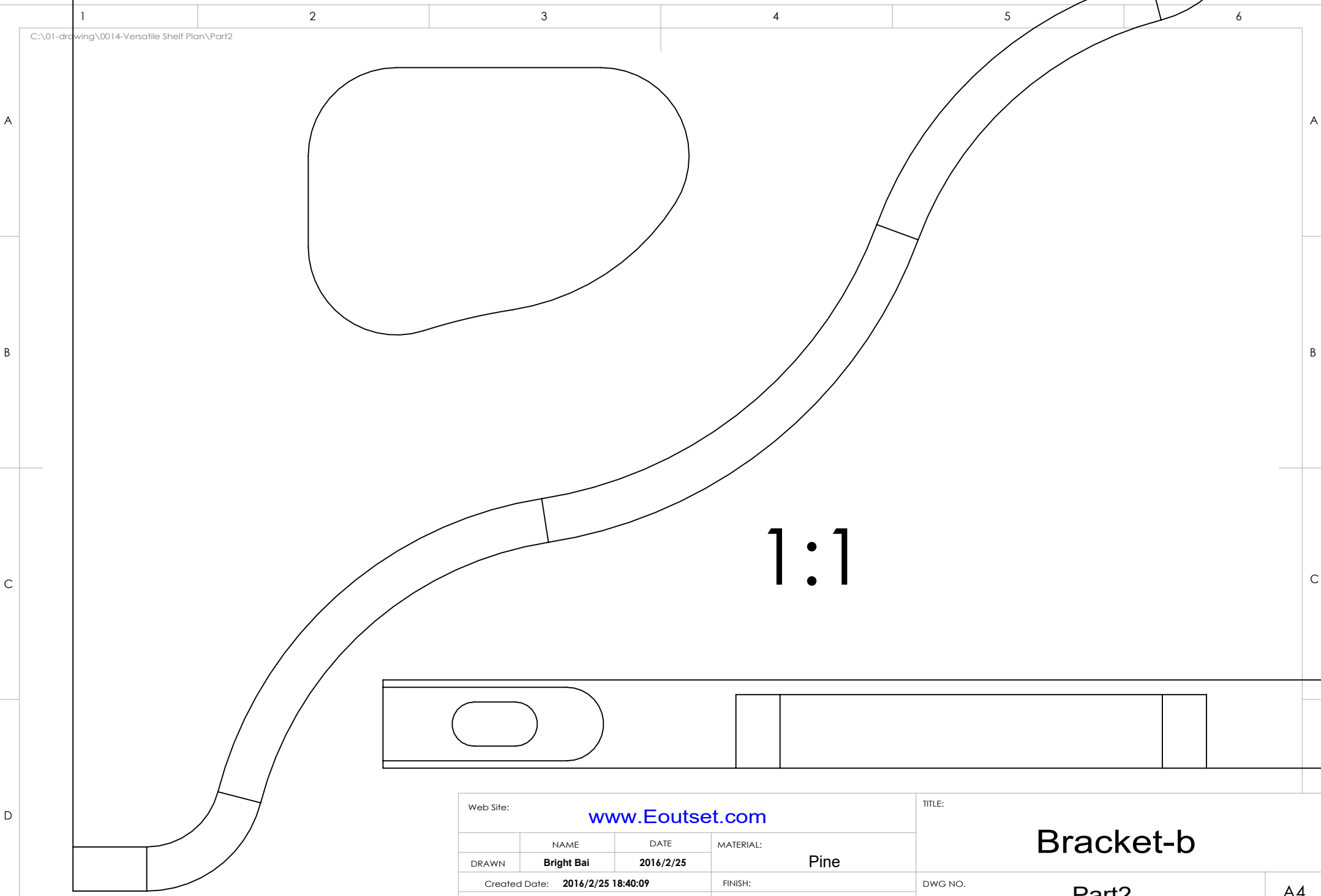

1:1

Web Site: <a href="http://www.Eoutset.com">www.Eoutset.com</a>			TITLE: <b>Bracket-b</b>		
DRAWN	NAME	DATE	MATERIAL:		
	<b>Bright Bai</b>	<b>2016/2/25</b>	<b>Pine</b>		
Created Date: <b>2016/2/25 18:40:09</b>			FINISH:	DWG NO. <b>Part2</b>	
Last Save Date: <b>2016/2/25 18:49:20</b>			Volume: <b>32.01 inches^3</b>	<b>A4</b>	
Author Email: <b>brightbai@hotmail.com</b>			Weight: <b>0.39 pounds</b>	SCALE: 1:1	SHEET 3 OF 3
			REVISION		

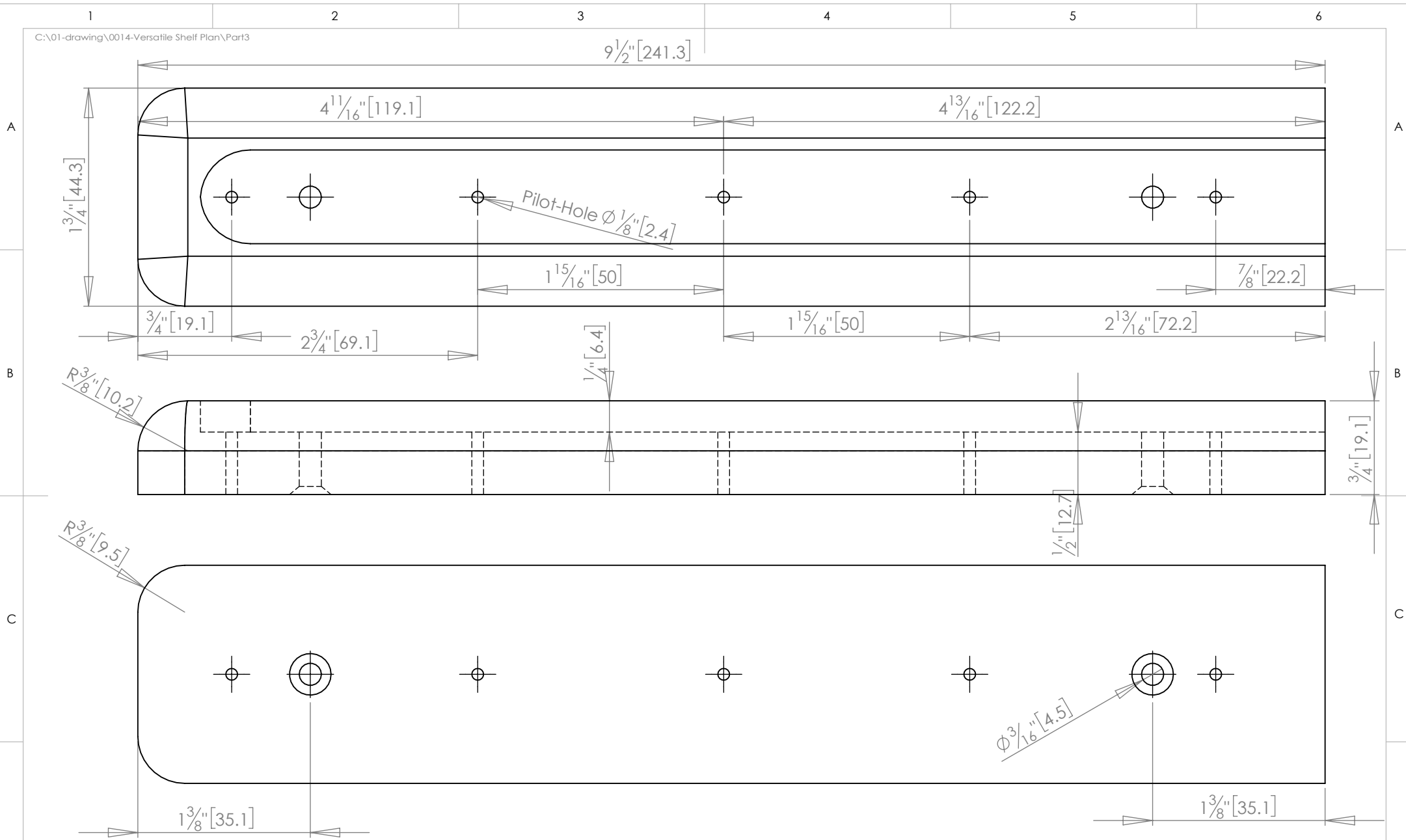

Web Site: <a href="http://www.Eoutset.com">www.Eoutset.com</a>			TITLE: <b>Cleat</b>	
DRAWN	NAME	DATE	MATERIAL: <b>Pine</b>	
	<b>Bright Bai</b>	<b>2016/2/25</b>		
Created Date: <b>2016/2/25 18:50:40</b>			FINISH:	DWG NO.
Last Save Date: <b>2016/2/25 19:18:09</b>			Volume: <b>9.98 inches^3</b>	<b>Part3</b>
Author Email: <b>brightbai@hotmail.com</b>			Weight: <b>0.12 pounds</b>	<b>A4</b>
			SCALE: 1:2	REVISION
			SHEET 1 OF 2	

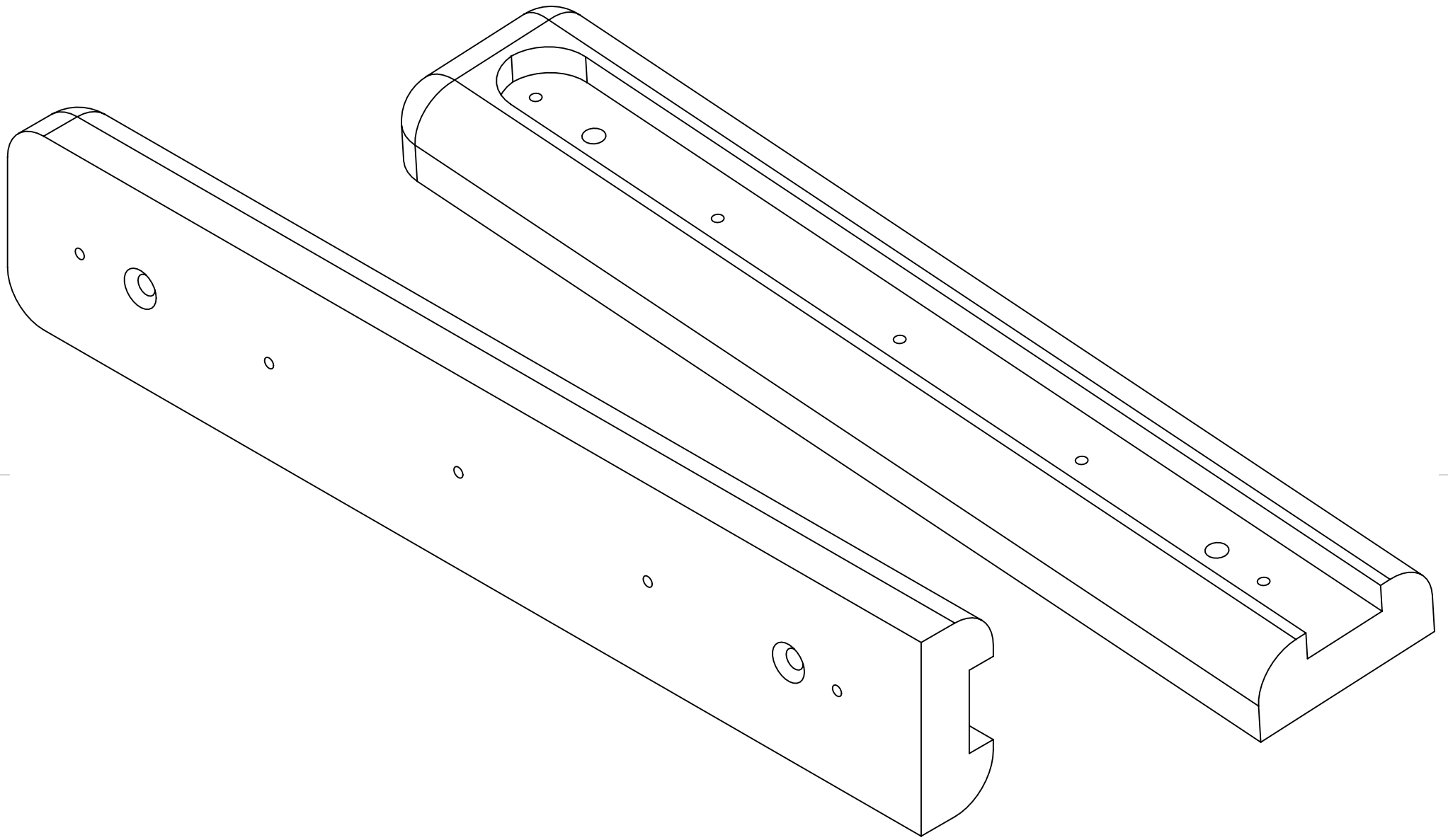

Web Site: <a href="http://www.Eoutset.com">www.Eoutset.com</a>			TITLE: <b>Cleat</b>	
DRAWN	NAME: <b>Bright Bai</b>	DATE: <b>2016/2/25</b>	MATERIAL: <b>Pine</b>	
Created Date: <b>2016/2/25 18:50:40</b>			FINISH:	
Last Save Date: <b>2016/2/25 19:18:09</b>			Volume: <b>9.98 inches^3</b>	
Author Email: <b>brightbai@hotmail.com</b>			Weight: <b>0.12 pounds</b>	
			DWG NO. <b>Part3</b>	
			SCALE: 1:1	
			SHEET 2 OF 2	
			REVISION	
			A4	

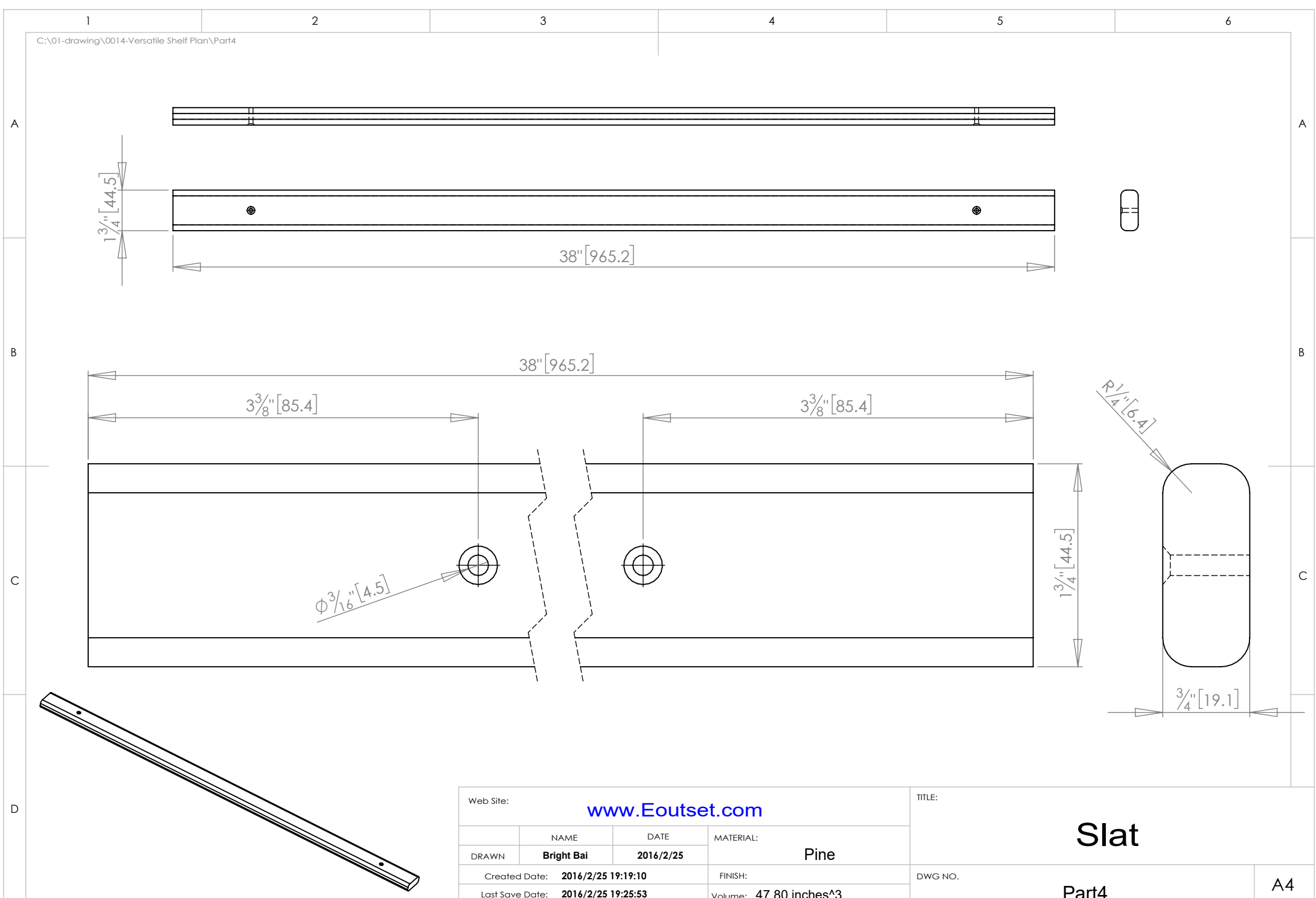

Web Site: <a href="http://www.Eoutset.com">www.Eoutset.com</a>			TITLE: <b>Slat</b>	
DRAWN	NAME	DATE	MATERIAL: <b>Pine</b>	
	<b>Bright Bai</b>	<b>2016/2/25</b>	DWG NO. <b>Part4</b>	
Created Date: <b>2016/2/25 19:19:10</b>			Volume: <b>47.80 inches^3</b>	
Last Save Date: <b>2016/2/25 19:25:53</b>			Weight: <b>0.59 pounds</b>	
Author Email: <b>brightbai@hotmail.com</b>			SCALE: 1:1	SHEET 1 OF 1
			REVISION	

A4

